

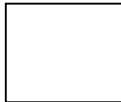

Installationsanvisning / Assembly instruction

Art nr: 74261 / 74263 / 74273

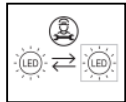

Ljuskällan och i denna armatur får endast bytas ut av tillverkaren eller av tillverkaren utsedd person.

The light source contained in this luminaire shall only be replaced by the manufacturer or a person designated by the manufacturer.

Denna produkt innehåller en ljuskälla med energieffektivitetsklass F / This product contains a light source of energy efficiency class F



74261, 74263
74273

⚠️ Armaturen ska monteras av behörig installatör.

Viktigt: Bryt spänningen före installation.

Installation:

1. Försäkra er om att spänning och frekvens på armaturen och nätet överensstämmer.
2. Avlägsna skärmen och det övre bländskyddet (4x skruv).
3. Montera bakstycket på vägg med lämplig skruv (fig. 1).
4. Anslut kabeln till kopplingsplinten A.
5. Montera åter skärmen och bländskyddet (glöm inte taggbrickorna (B) mot skärmen).

⚠️ Installation must be carried out by a qualified electrician.

Important: Switch off the mains voltage before installation.

Installation:

1. Ensure that voltage and Hz on the fixture and mains voltage are the same.
2. Remove the shade and the upper diffuser (4x screws).
3. Mount the fixture on the wall with suitable screws (fig. 1).
4. Connect the cable into the terminal block (A).
5. Remount the shade and the diffuser (don't forget the tooth washers (B) against the shade).

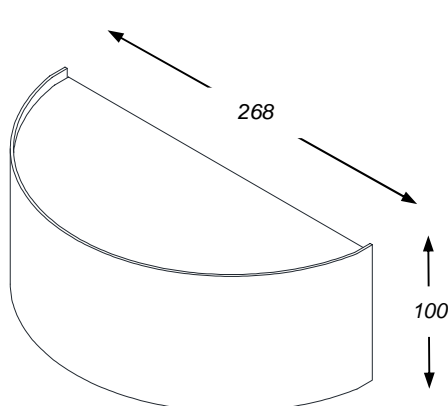

74261

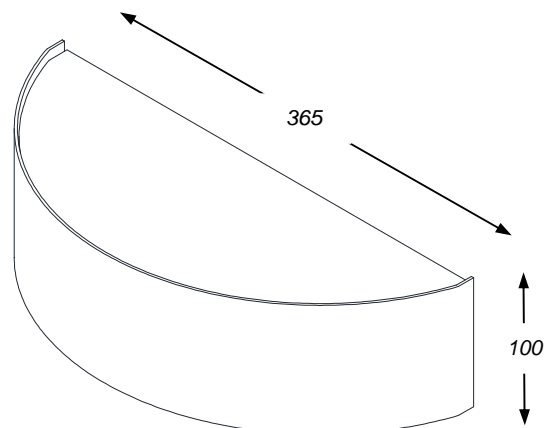

74263 / 74273



Fig.1

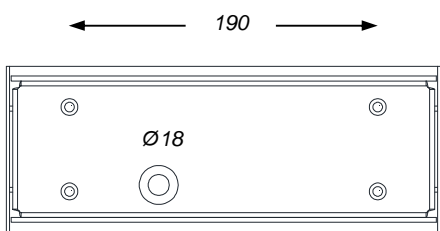
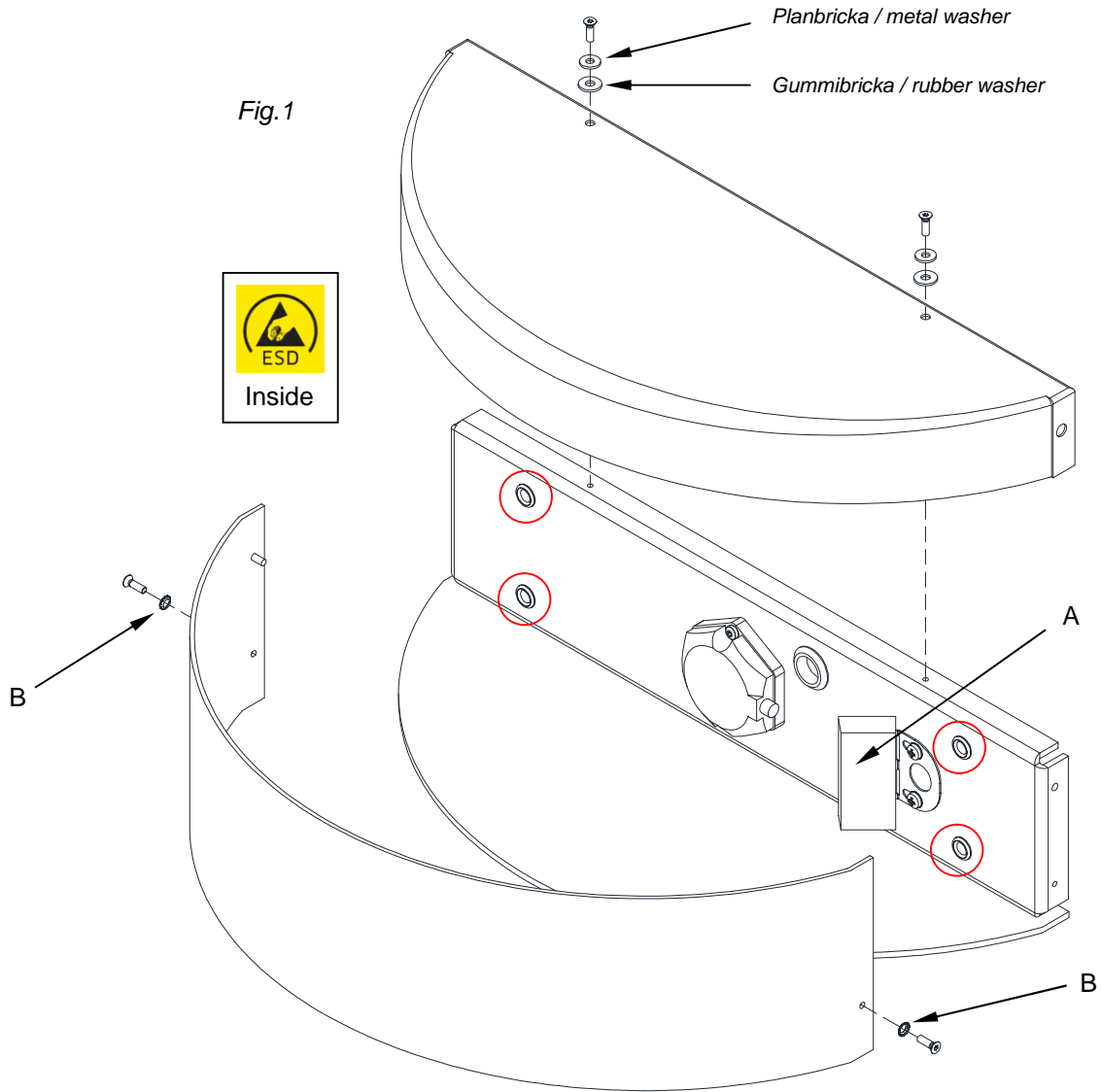

74261

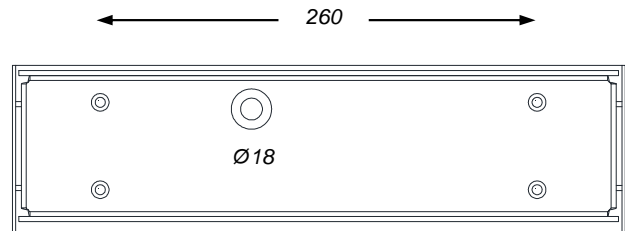

74263 / 74273

Rengöringsinstruktioner och återvinningsanvisningar finns på www.zero.se
Cleaning and recycling instructions are available at www.zerolighting.com